

Name: _____

Exam Style Questions



Enlargements: Ray Method

Corbettmαths

Ensure you have: Pencil, pen, ruler, protractor, pair of compasses and eraser

You may use tracing paper if needed

Guidance

1. Read each question carefully before you begin answering it.
2. Don't spend too long on one question.
3. Attempt every question.
4. Check your answers seem right.
5. Always show your workings

Revision for this topic

Secondary

Video 109

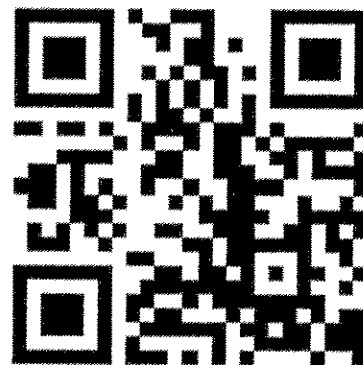

1.

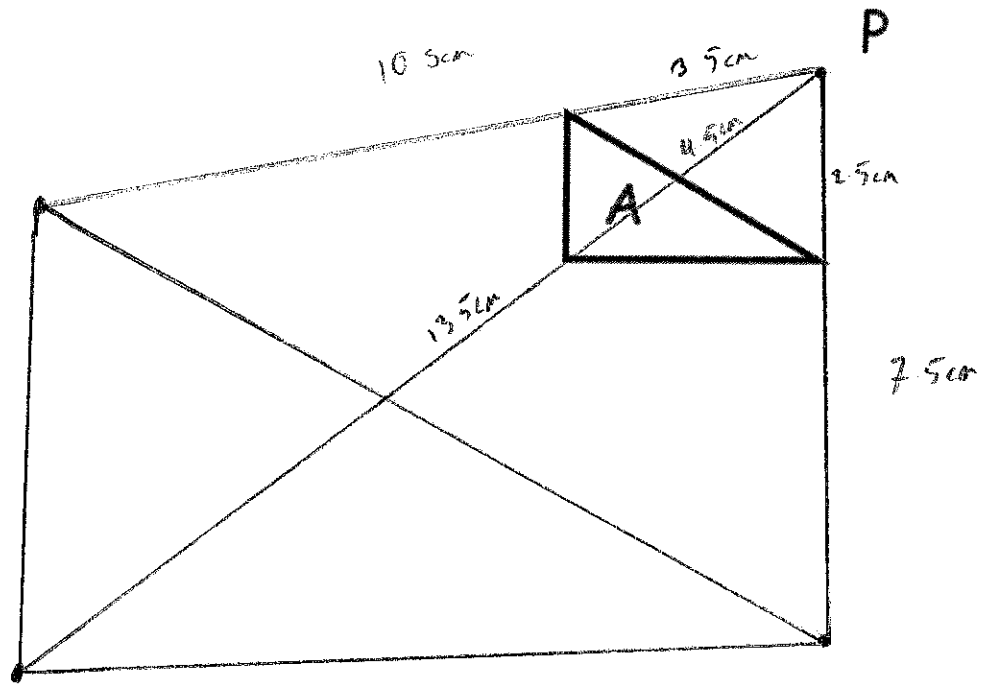

Enlarge triangle A by scale factor 3, using P as a centre of enlargement.

(3)

2.

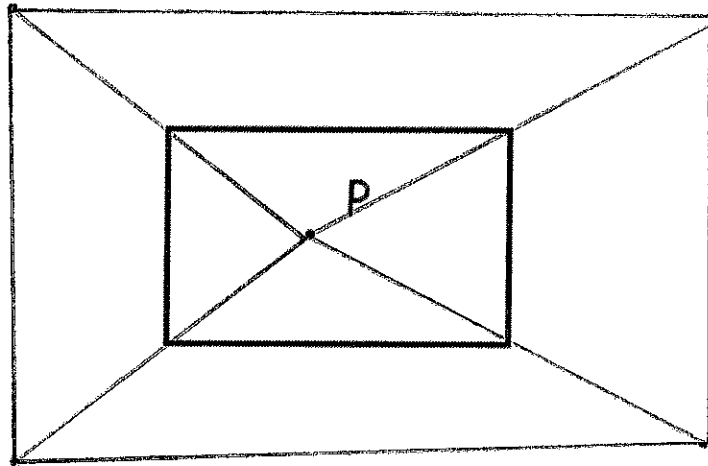

Enlarge the rectangle by scale factor 2, using P as a centre of enlargement.

(3)

3.

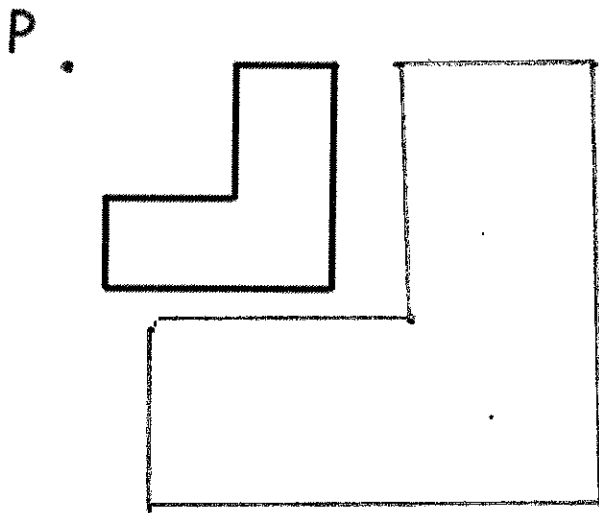

Enlarge the L-shape by scale factor 2, using P as a centre of enlargement.

(3)

4.

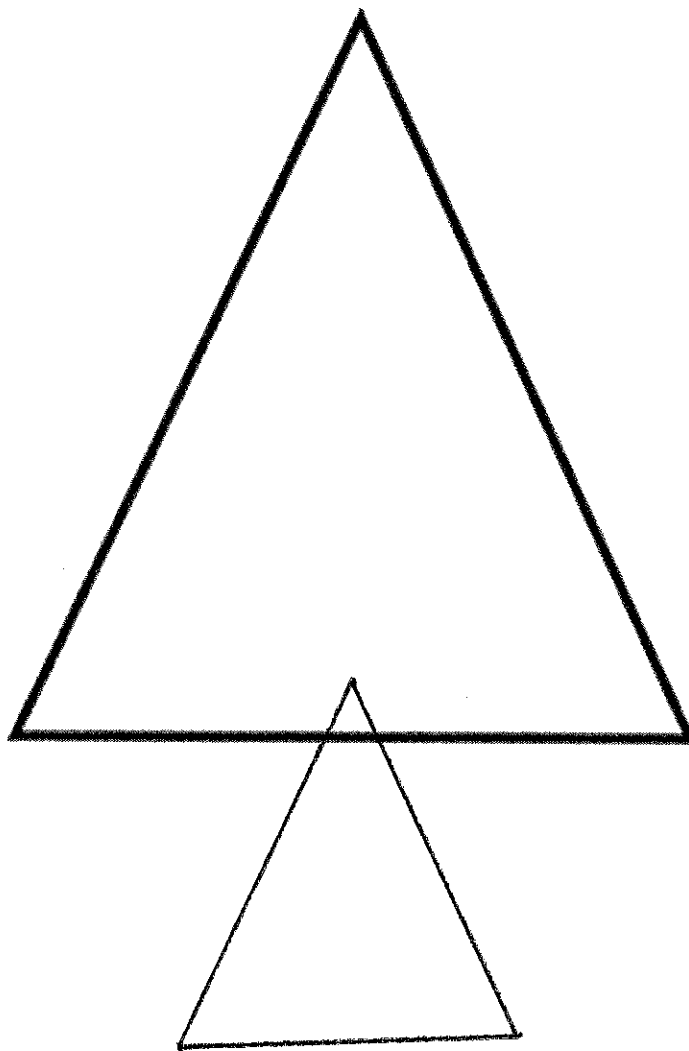

P .

Enlarge the triangle by scale factor $\frac{1}{2}$, using P as a centre of enlargement.

(3)

5.

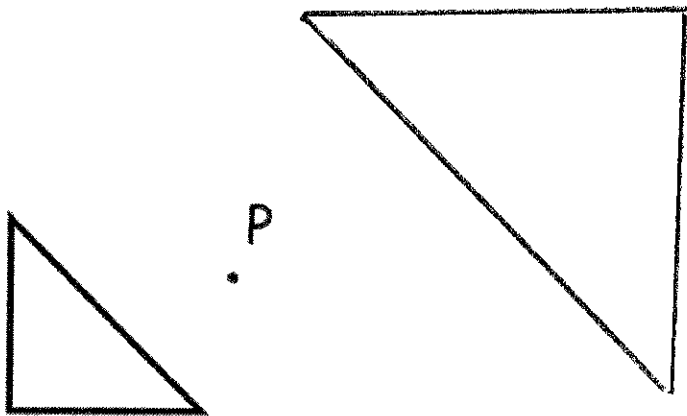

Enlarge the triangle by scale factor -2 , using P as a centre of enlargement.

(3)

6. Triangle B is an enlargement of triangle A.

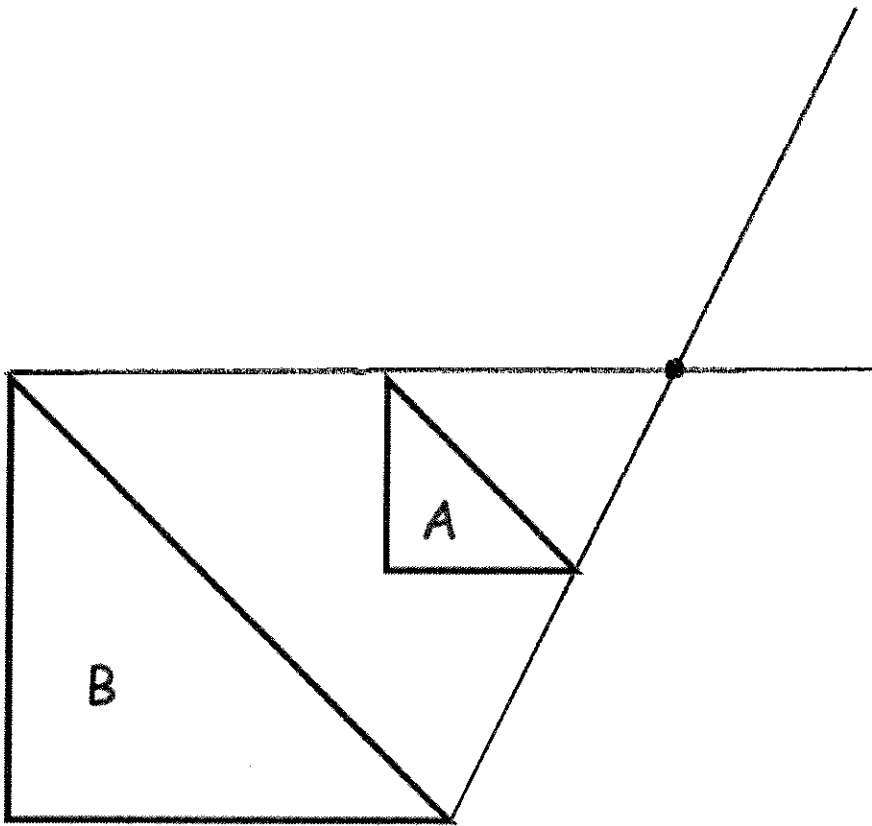

Find the centre of enlargement.

(1)