

Name: _____

Exam Style Questions



Views and Elevations Corbettmaths

Ensure you have: Pencil, pen, ruler, protractor, pair of compasses and eraser

You may use tracing paper if needed

Guidance

1. Read each question carefully before you begin answering it.
2. Don't spend too long on one question.
3. Attempt every question.
4. Check your answers seem right.
5. Always show your workings

Revision for this topic

www.corbettmaths.com/contents

Video 354



1. The diagram below shows a shape made with centimetre cubes.

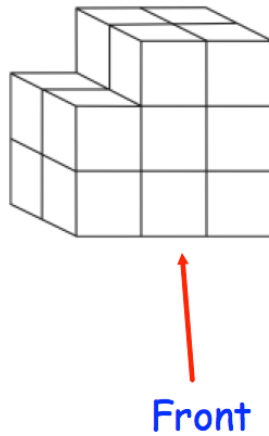

(a) On the centimetre square grid, draw the front elevation.

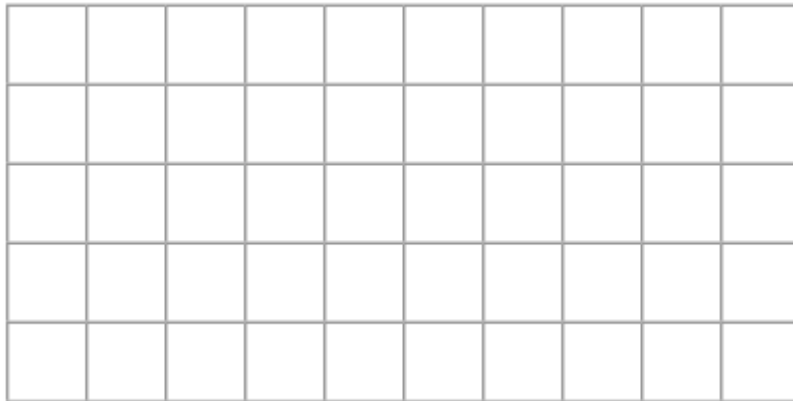

(2)

(b) On the centimetre square grid, draw the side elevation.

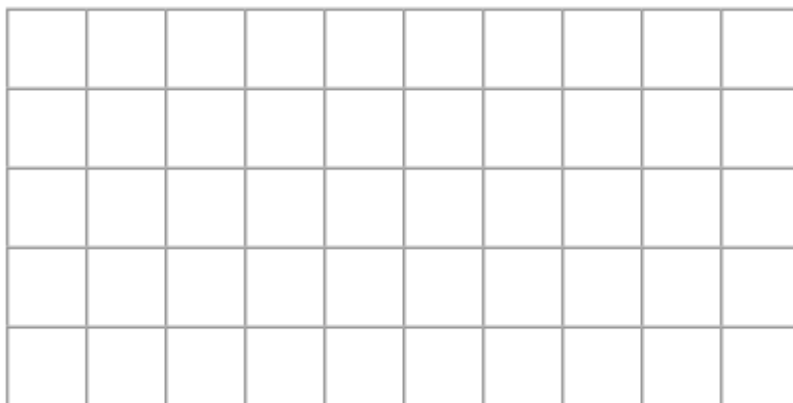

(2)

2. The diagram below shows a shape made with centimetre cubes.

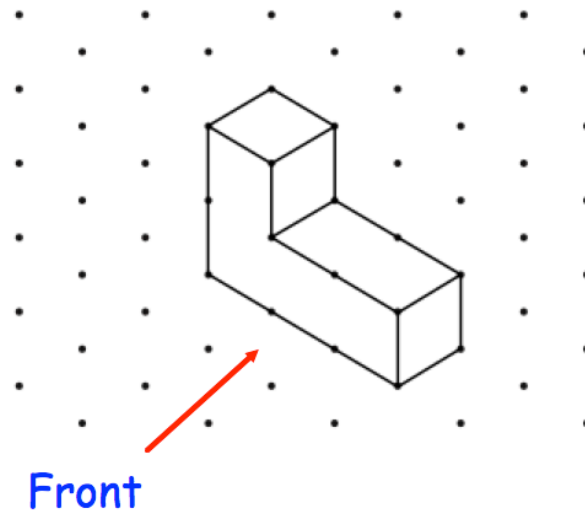

(a) On the centimetre square grid, draw the front elevation.

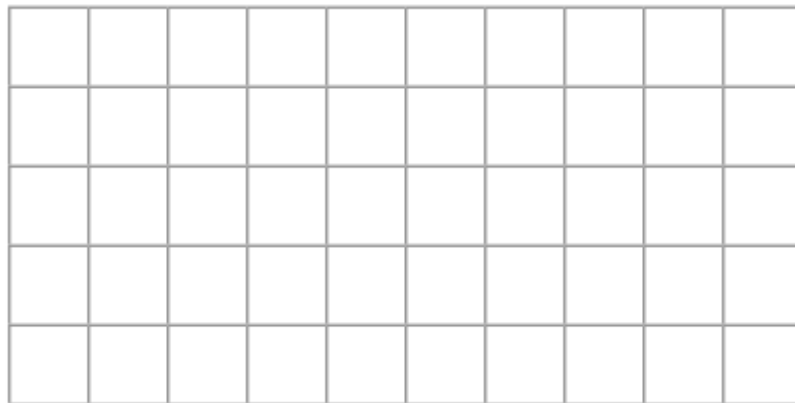

(2)

(b) On the centimetre square grid, draw the plan view.

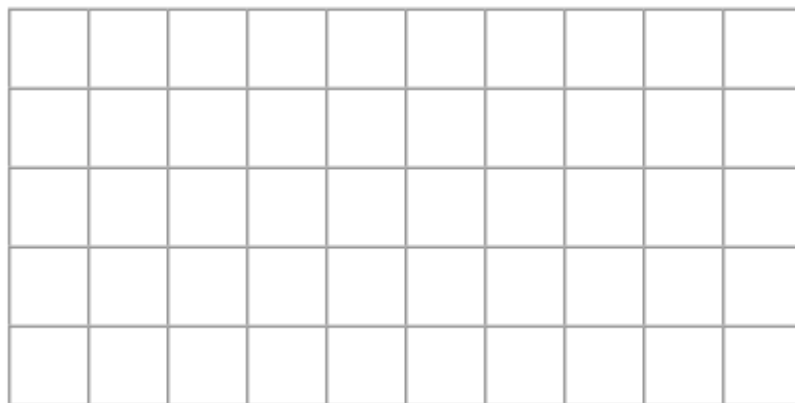

(2)

3. The diagram below shows a shape made with centimetre cubes.

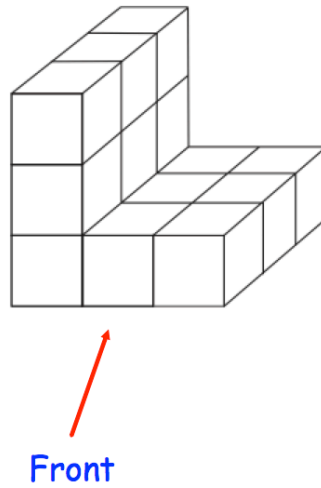

(a) On the centimetre square grid, draw the front elevation.

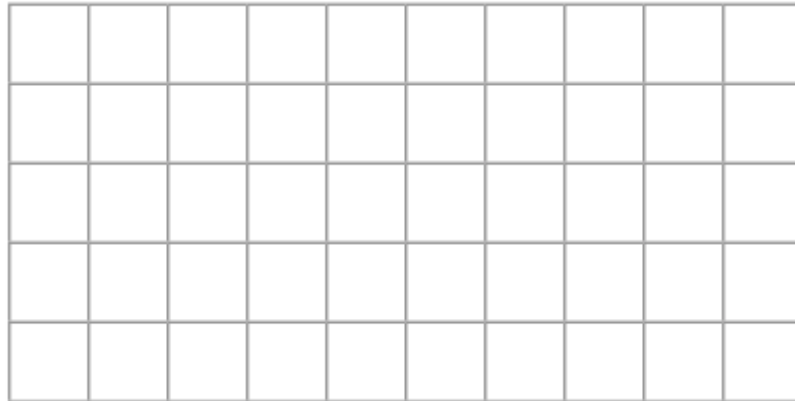

(2)

(b) On the centimetre square grid, draw the plan view.

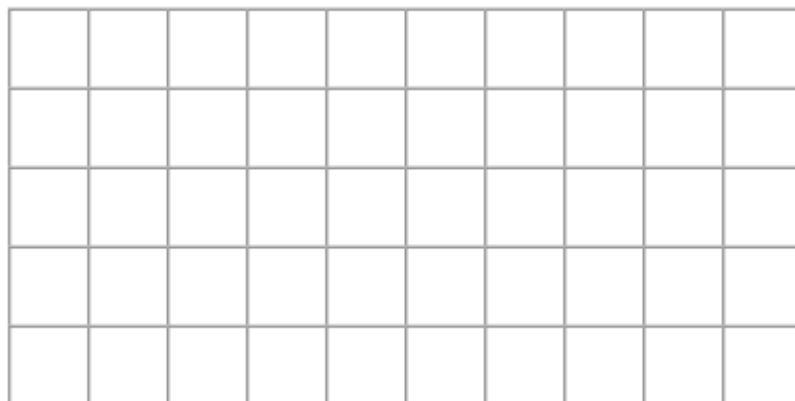

(2)

4. The diagram below shows a shape made with centimetre cubes.

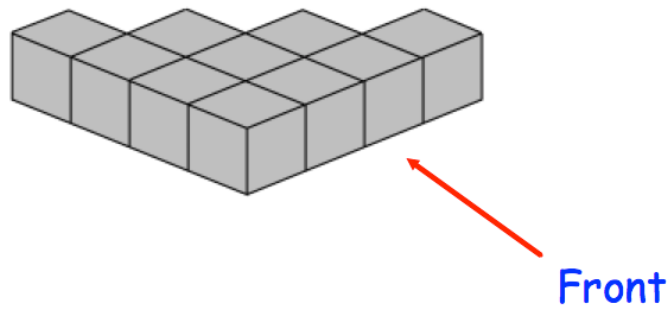

(a) On the centimetre square grid, draw the front elevation.

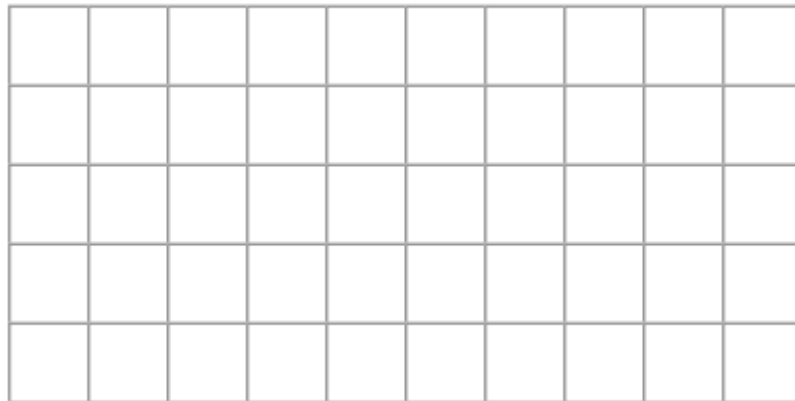

(2)

(b) On the centimetre square grid, draw the plan view.

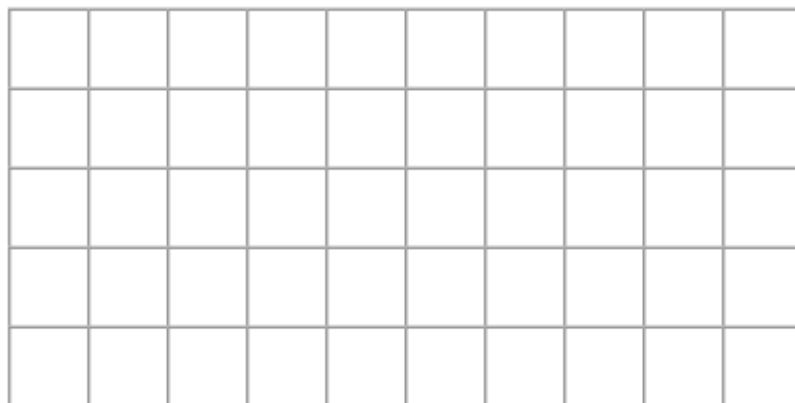

(2)

5. Shown below is a cuboid.

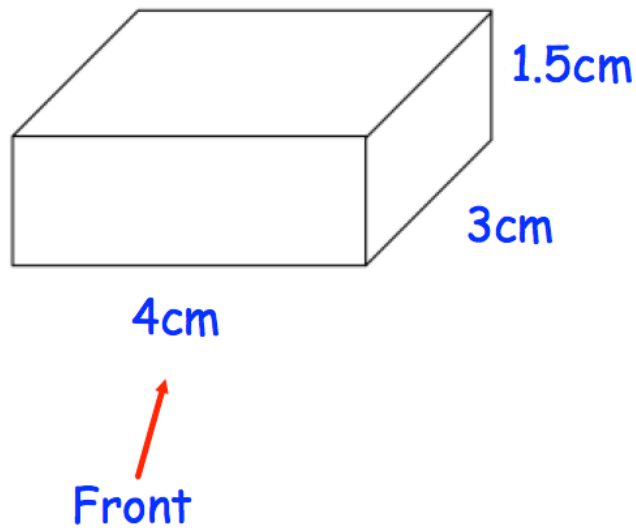

(a) On the centimetre square grid, draw the front elevation.

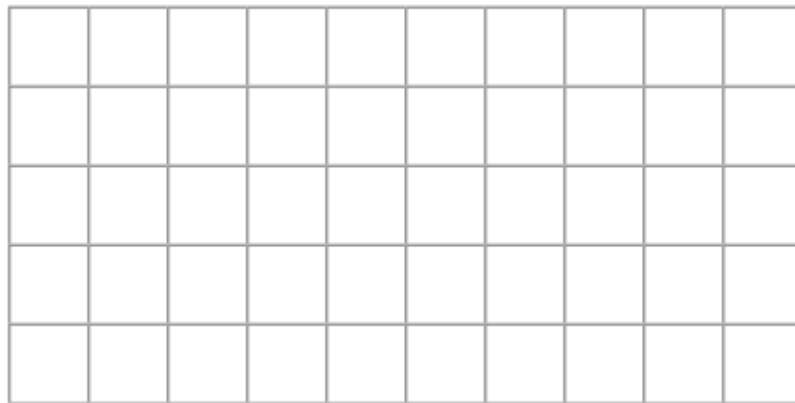

(2)

(b) On the centimetre square grid, draw the plan view.

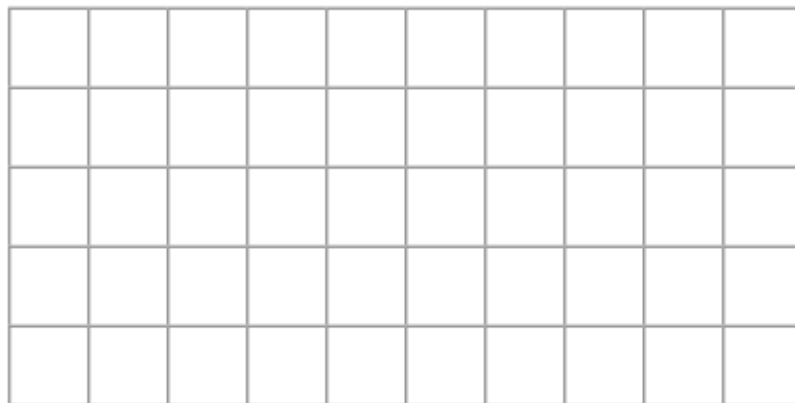

(2)

6. Shown below is a solid shape made from centimetre cubes.

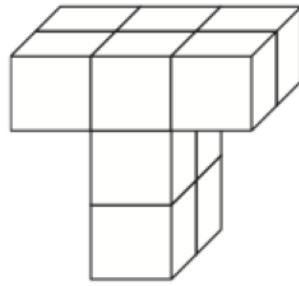

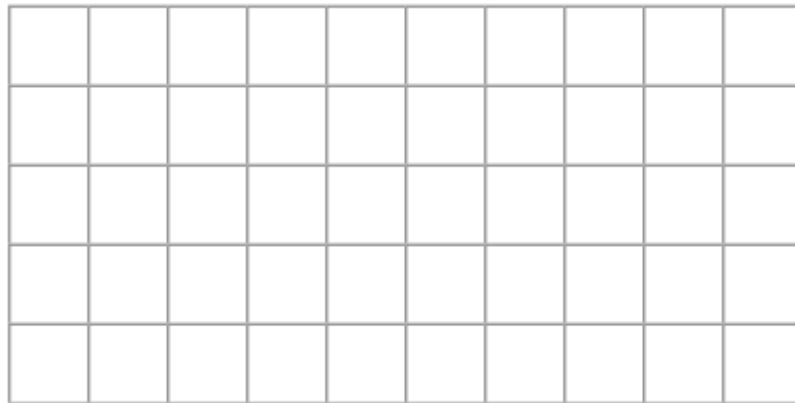

Front

(a) On the centimetre square grid, draw the front elevation.

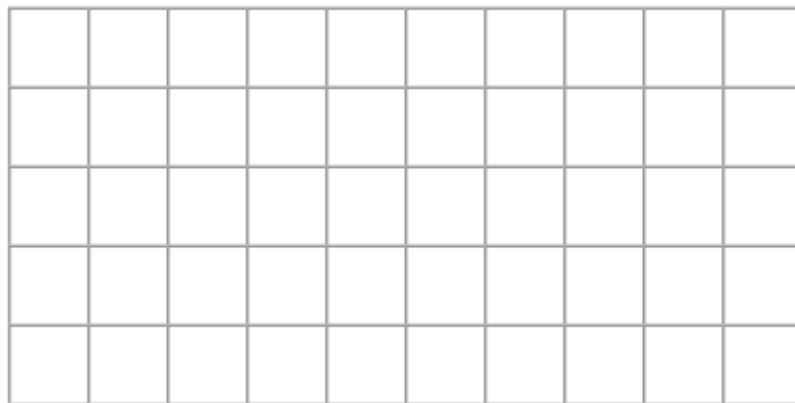

(2)

(b) On the centimetre square grid, draw the plan view.



(2)

7. Here are the front and side elevations of a solid shape.

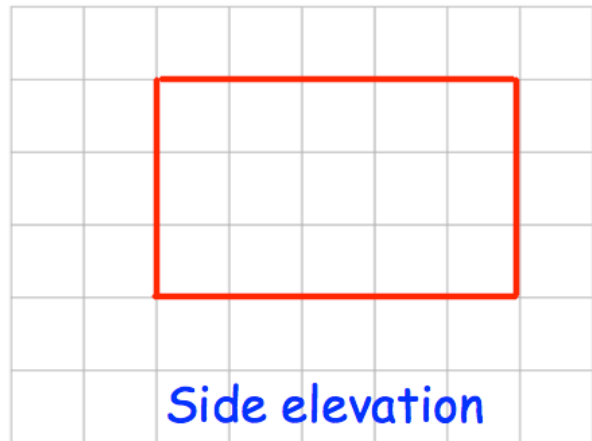
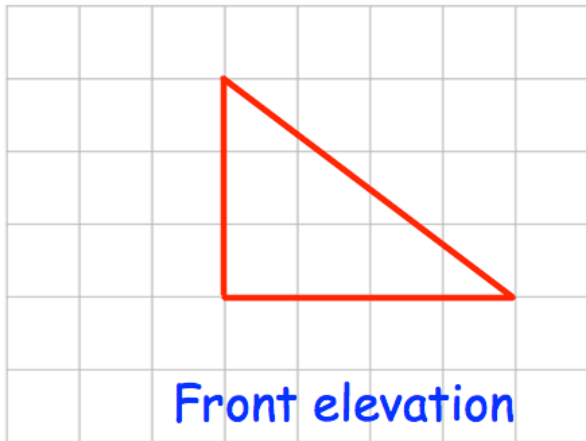

(a) On the grid, draw the plan view.

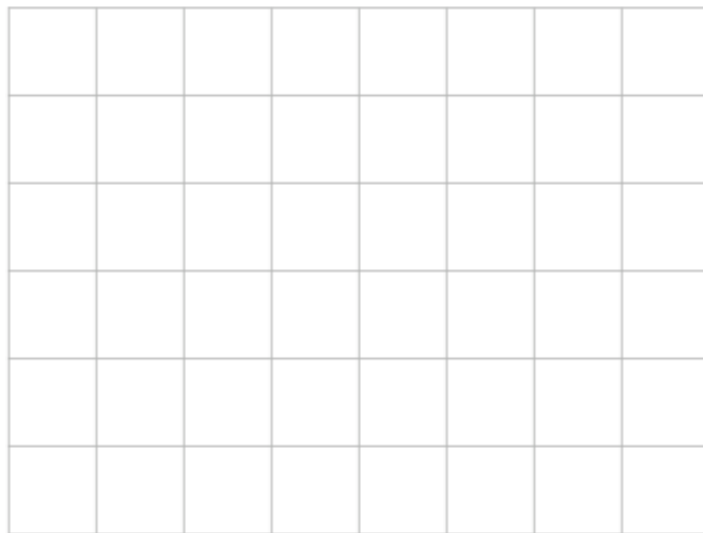

(2)

(b) Draw a sketch of the solid shape.

(2)

8. Here are the front elevation and plan view of a solid shape.

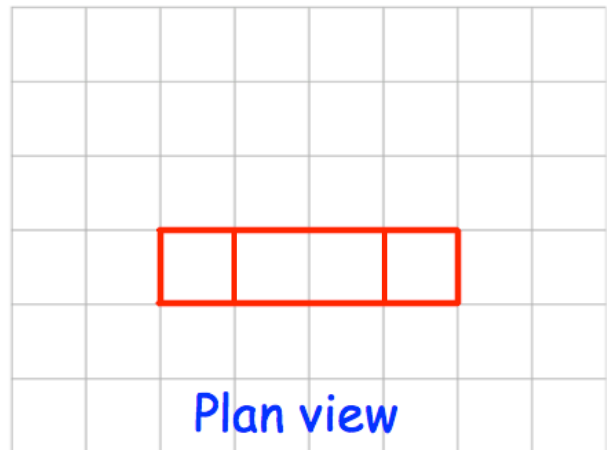
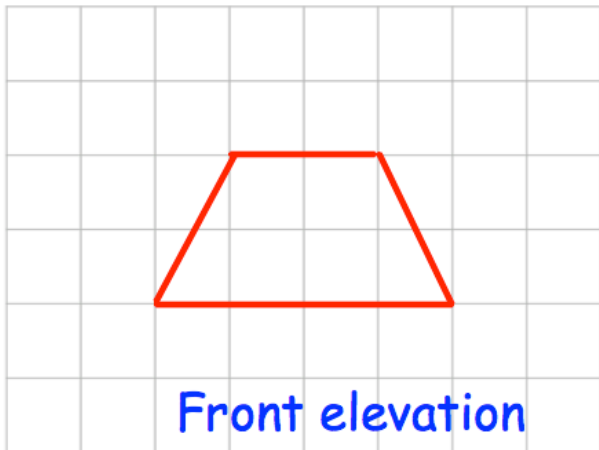

(a) On the grid, draw the side elevation.

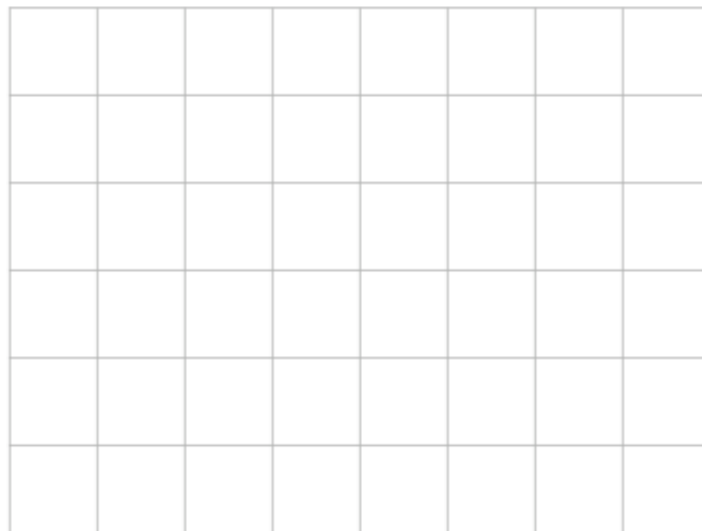

(2)

(b) Draw a sketch of the solid shape.

(2)

9. The front elevation of a solid shape is a circle.
The side elevation of the solid shape is a rectangle.
The plan view of the solid shape is a rectangle.

Write down the name of the shape.

.....
(1)

10. The front elevation of a solid shape is a triangle.
The side elevation of the solid shape is a triangle.
The plan view of the solid shape is a circle.

Write down the name of the shape.

.....
(1)

11. The front elevation of a solid shape is a triangle.
The side elevation of the solid shape is a triangle.
The plan view of the solid shape is a square.

Write down the name of the shape.

.....
(1)