

Name:

Exam Style Questions

Area of a Rectangle



Equipment needed: Calculator, pencil, ruler & pen

Guidance

1. Read each question carefully before you begin answering it.
2. Check your answers seem right.
3. Always show your workings

Video Tutorial

www.corbettmaths.com/contents

Video 45



Answers and Video Solutions



1. On the grid below each square represents 1cm by 1cm.

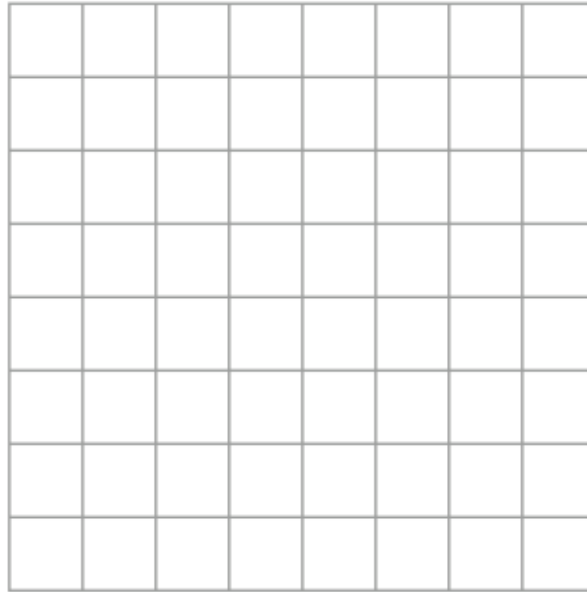

Draw a rectangle with an area of 10cm^2 .

(2)

2. On the grid below each square represents 1cm by 1cm.

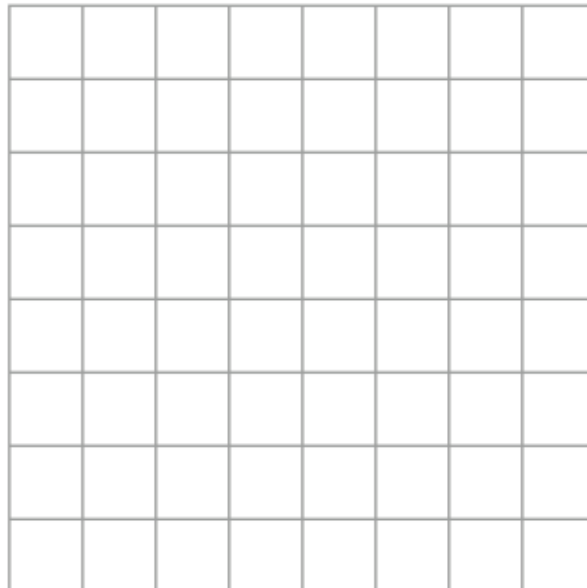

Draw a rectangle with an area of 8cm^2 .

(2)

3. The diagram shows a rectangle.

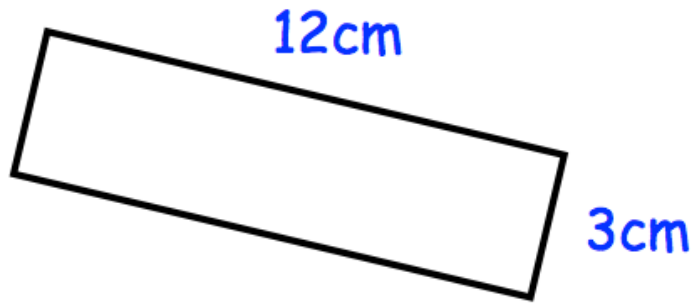

Work out the area.
Include units.

.....
(3)

4. Shown below is a rectangle.

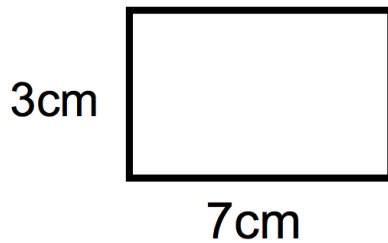

Work out the area.

.....cm²
(2)

5. The diagram shows a rectangle.



12cm



The length of the rectangle is 12cm
The area of the rectangle is 48cm^2

Find the width of the rectangle.

.....cm
(2)

6.



4.5cm



2.8cm

The rectangle has length 4.5cm and width 2.8cm.

Work out the area.

..... cm^2
(2)

7. Shown below is a rectangle.

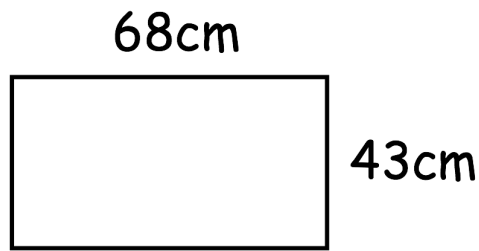

Work out the area of the rectangle.

.....cm²
(2)

8. The width of a rectangle is 28cm
The area of the rectangle is 1540cm²



Work out the length of the rectangle.

.....cm
(2)

9. Shown below is a wooden picture frame.

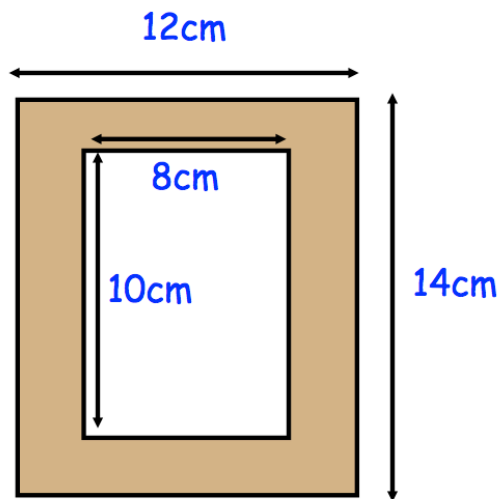

Work out the shaded area.

.....cm²
(3)

10. The rectangle below has an area of 65cm².

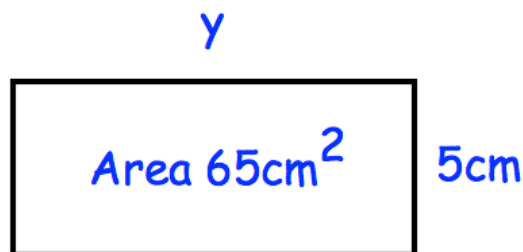

Work out the size of y.

.....cm
(2)

11. The perimeter of a square is 28cm.



Find the area of the square.

.....cm²
(2)

12. The rectangle below has an area of 36cm²

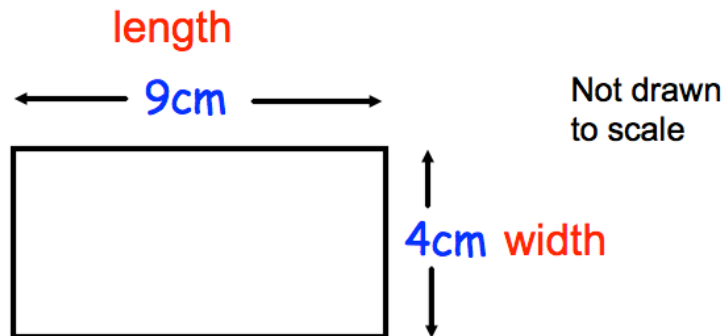

The rectangle has length 9cm and width 4cm.

Write down the length and width of **two** other rectangles with area 36cm².

Rectangle 1: lengthcm widthcm

Rectangle 2: lengthcm widthcm

(2)

13. Shown below is a square and a rectangle.



Square

Rectangle

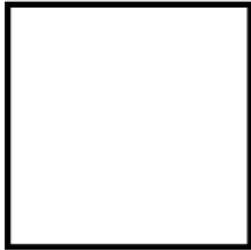

8cm



16cm

The square and rectangle have the same area.

Find the y.

.....cm
(3)

14. Work out the area of the rectangle below.

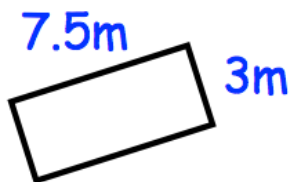

Include units.

.....
(3)

15. A rectangle is 3cm by 6cm.

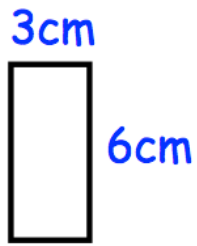

Six of the rectangles are used to make a larger rectangle.

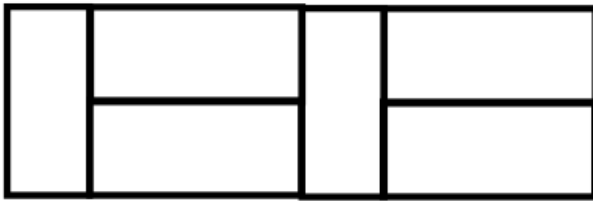

Work out the area of the larger rectangle.

.....cm²
(2)

16. The diagram shows a rectangle.

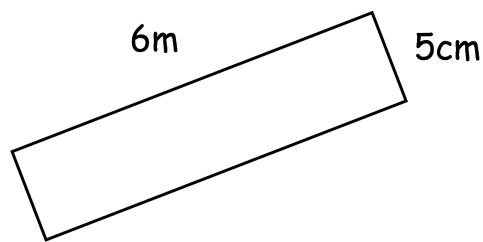

Not to scale

Work out the area.
Give your answer in centimetres squared.

.....cm²
(3)

17. Jessica wants to lay artificial grass in her rectangular garden.

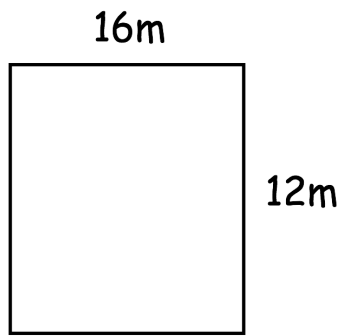

Each square metre of artificial grass costs £23

How much should Jessica pay for the artificial grass?

£.....

(3)

18. On the grid below each square represents 1cm by 1cm.

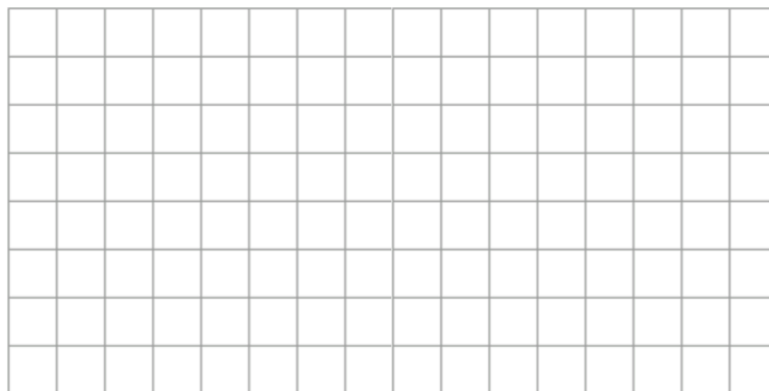

A rectangle has an area of 36cm^2

The length of the rectangle is 4 times greater than the width of the rectangle.

Draw the rectangle on the grid.

(2)

19. Here is a rectangle with perimeter 30cm.

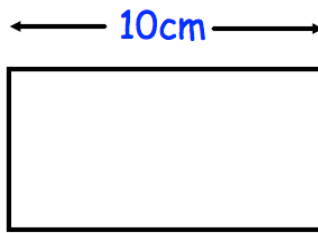

Not drawn to scale

The length of the rectangle is 10cm.

Work out the area of the rectangle.

.....cm²
(3)

20.

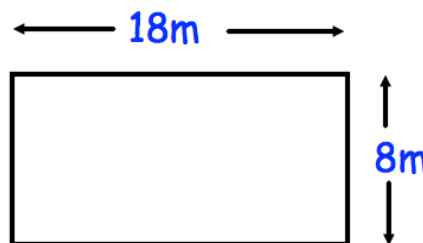

Not drawn to scale

Mrs Jenkins is a chicken farmer.
Her chicken pen is 18m long and 8m wide.
Each chicken requires at least 3m².

What is the maximum number of chickens Mrs Jenkins can keep?

.....
(4)

21. Shown below is a cuboid.

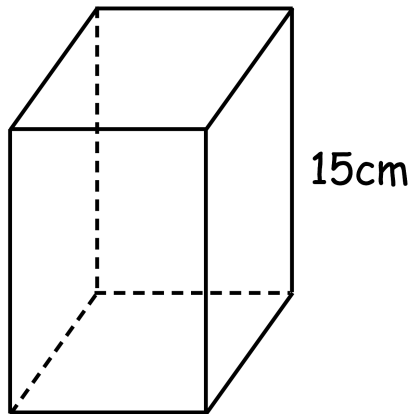

The base of the cuboid is a square and the height of the cuboid is 15cm.

The total length of the 12 edges is 112cm.

Find the area of the base of the cuboid.

.....cm²
(4)

22. Rory made a rectangular logo, 8cm long and 5cm wide.

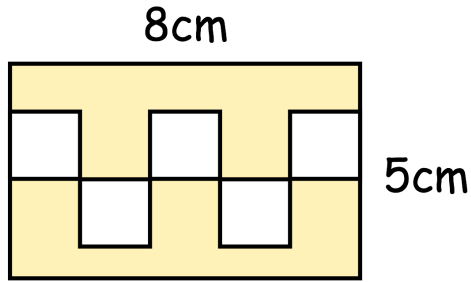

There are 5 identical white squares and the rest of the logo is shaded.

Find the area of the logo that is shaded.

.....cm²
(4)

23. Shown below is a rectangle with length 20cm and width 10cm.

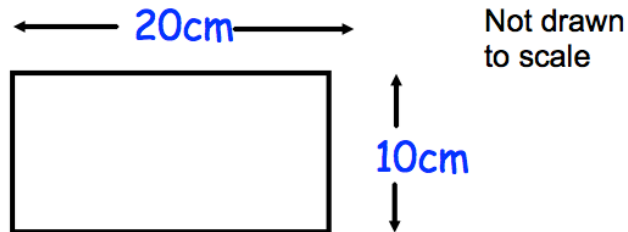

The length of the rectangle is increased by 20%.

The width of the rectangle is increased by 5%.

Find the percentage increase in the area of the rectangle.

.....%
(3)

24. Rebecca draws a rectangle.
Holly enlarges the rectangle by scale factor 2.



Rebecca states “the area will be twice as larger as the original rectangle.”

Show Rebecca is incorrect.

(4)

25. Shown below are rectangles A and B.

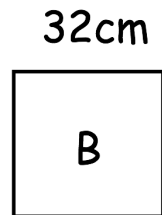
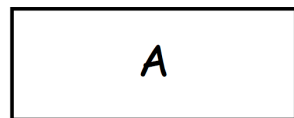

Both rectangles have the same area.
The perimeter of rectangle B is 114cm.

The length of rectangle A is 8 times larger than its width.

Find the length of rectangle A.

.....cm

(5)

26. Mr Jones is tiling his kitchen floor.



The kitchen floor measures 3m by 2m.
Each tile is 30cm by 20cm.

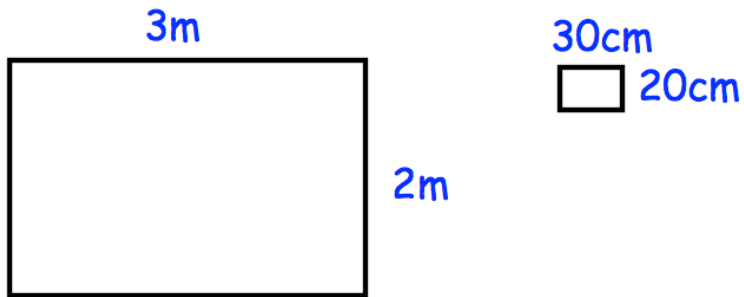

How many tiles does he need?

.....
(3)

27. Jessica is tiling her bathroom wall.



The wall is 240cm by 200cm.
The tiles are squares with side length 20cm.

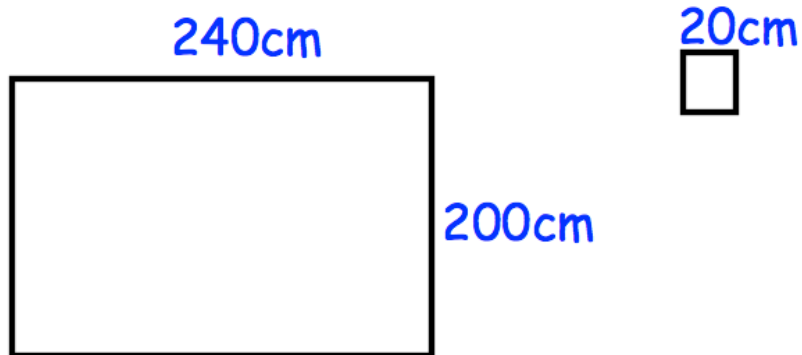

Each box contains 15 tiles and costs £8.75.

How much will it cost Jessica for the tiles?

£.....

(5)

28.

ABCD is a rectangle.



The length of the rectangle, AB, is 40% longer than the width of the rectangle, AD.

A square AEFG is then removed from rectangle ABCD to leave a hexagon.

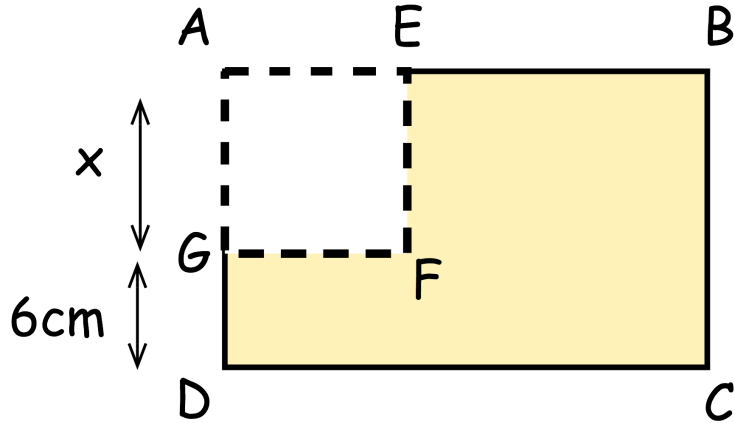

Given that $x : 6 = 3 : 2$

Find the area of the hexagon.

.....cm²
(5)